

MaxMotion

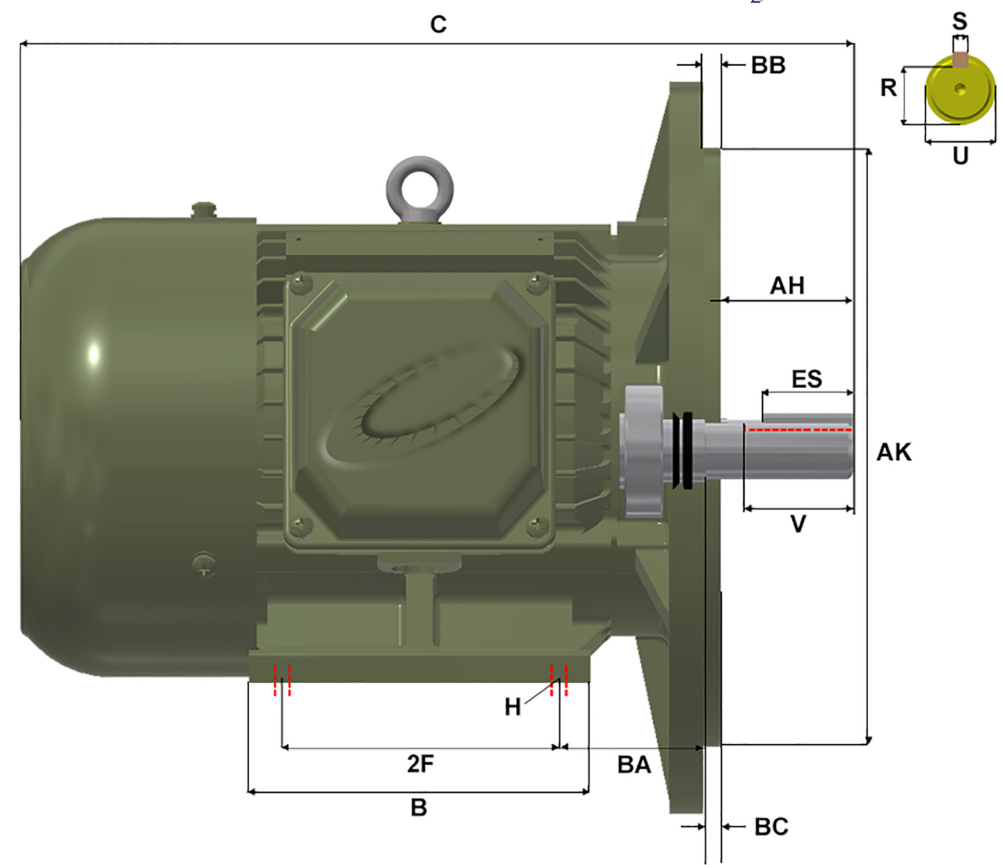
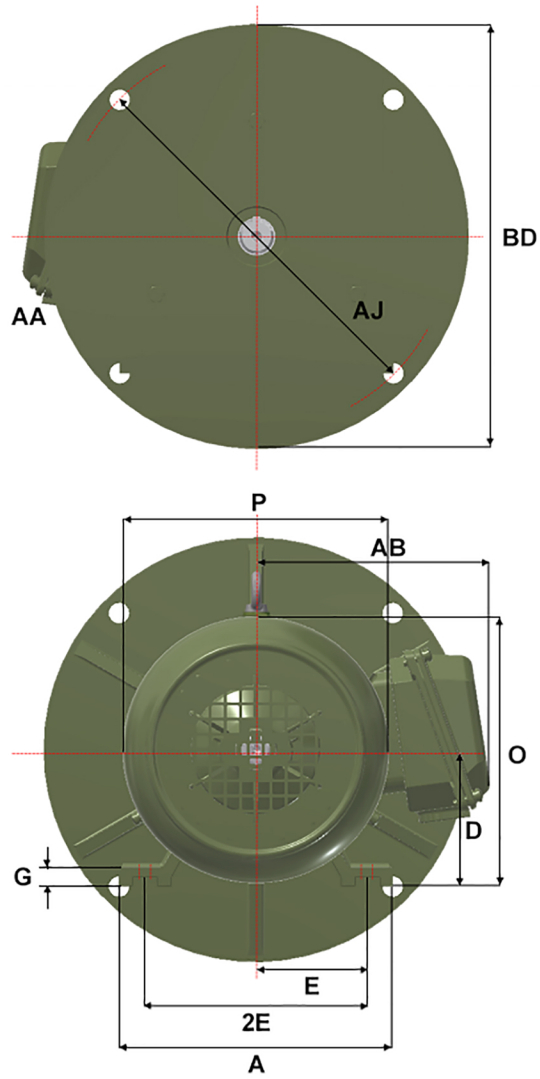

Version: 2WTI		Revised: 08-10-2019		HP	RPM	FRAME	ENCLOSURE	MPP/MQP-57D					
Customer is responsible in determining that MEP product will fit/perform suitably in the intended application				40	1800	324TD	TEFC						
A	B	C	D	E	2E	2F	G	H	O	P	R	S	
15.50	14.70	29.80	8.00	6.25	12.50	10.50	1.00	4 * 0.66	15.90	15.70	1.845	0.50	
T	U	V	AA	AB	AH	AJ	AK	BA	BB	BC	BD	ES	
2.60	2.125	5.00	2 NPT	12.30	5.25	16.00	14.00	5.25	0.25	0.00	18.00	3.91	